

The WLSP-32 louvre window is suitable for natural ventilation or natural smoke (NSHEV) applications. Designed on the solidity of our WL range, but incorporating frameless, solid panel, insulated louvre blades for a high performance and aesthetic design.

- For natural or natural smoke (NSHEV) applications.;
- 32mm aluminium skinned insulated panel blades.
- Frameless blade appearance.
- For installation in vertical facades
- Frame and sash profiles are thermally separated, made from composite of aluminium and PA6.6 / PT profiles
- Standard with 64° opening angle, up to 90° if required



EN12101-2 certified



Frameless blade appearance



See below for framing and motor types



Aluminium skinned insulated panels

WLSP-32 Certifications & Test Data	
Glazing Panel Thickness	32mm
Glazing Types	32mm aluminium skinned insulated panels
Frame Depth	60mm (+25mm on driven side)
Perimeter Frame Width	38mm
Unit Width	300-1800mm
Max Frame Height	Unlimited (sections)
Louvre Height	Fixed: 174mm, 192mm, 200mm, 211, 275mm, 344mm
Louvre Blade Framing	-
EN12101-2:2003	
Aerodynamic free area	Individual Calc.
Wind Load	WL 3000
Low Ambient Temperature	T (-20)
Reliability Class	Re 1000
Snow Load	SL 0
Resistance to heat	B 300-E
EN14351-1	
Air Permeability (EN12207)	Class 7A
Watertightness (EN12208)	Class 4
Wind Load Class (EN12210/12211)	Class C5
Durability (DIN EN 1191)	Class 3
Heat Transition Co-efficient (EN ISO 10077-1)	Individual calc. Up to 1.19W/m²K
Fall Protection (DIN EN 18008-4)	✓





WLSP-32

Construction

- Louvre windows for installation in vertical facades
- Thermally broken frame and sash profiles manufactured from extruded aluminum and PA6.6 / PT profiles.
- Louvre blades consist of aluminium skinned insulated panels.
- Louvre windows consist of one or more stacked louvres, which open on a central pivot. As a rule, the axis of rotation is in the middle of the louvre, but can also be modified up to 1/3 - 2/3 after technical clarification.
- Standard with 64° opening angle, up to 90° if requested.

Profile Dimensions

- Frame depth: 60mm
- Perimeter frame width: 38 mm
- Louvre blade frame width: N/A

Seals

- Vertical brush seals
- Horizontal profile joints with brush and EPDM seal

Fixings

- All unit fittings are concealed
- Made of corrosion-free or galvanised materials

Finishes

- Profiles can be anodised, powder coated or wet paint coated in RAL or special colours.
- Standard PPC to 40 Microns unless otherwise stated.

Applications

- Natural ventilation
- NSHEV certified to DIN EN 12101-2 for natural smoke ventilation
- For installation in vertical facades (further applications after technical clarification)

Size Range

- Minimum frame width: 300 mm
- Maximum frame width: 1800 mm
- Units exceeding maximum width will be supplied as 2 units, joining together on site.
- Louvre blade height fixed: 174mm, 192mm, 200mm, 211mm, 275mm, 344mm

Control Option	Notes
Manual Hand Lever	
Articulated Crank Rod	
230V AC	
24V DC	Suitable for NSHEV (EN12101-2)
24V DC with SK3 anti-trapping	Suitable for NSHEV (EN12101-2)
24V DC with SK3 anti-trapping & 10 year battery backup for auto close/open	Suitable for NSHEV (EN12101-2)
Pneumatic Cylinder	Suitable for NSHEV (EN12101-2)



Framing Options

Our WL-SP range is available with a number of different control and framing options to suit most applications. Bespoke options are available.

Standard framing

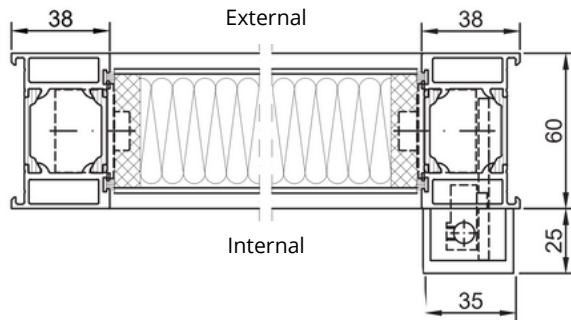

Extended framing (allowing space for internal finish)

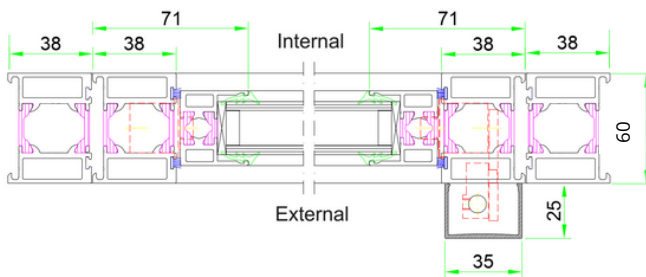

30mm Glazing Adapter

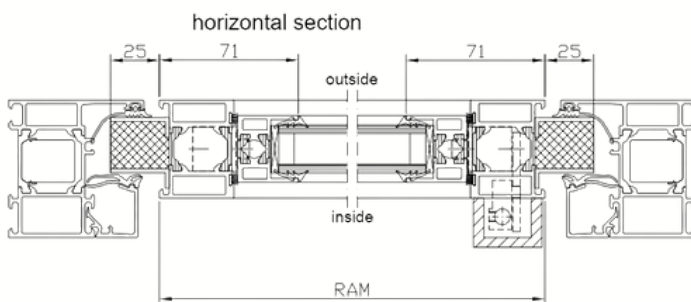

20mm Curtain Walling Adapter

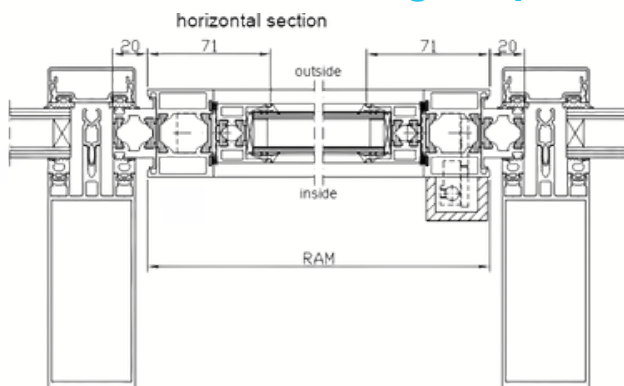

Vertical Section (no motor shown)

